

Table Top Rack Cabinets (RCHS Series) - *HEAVY DUTY*















Textured - Light Gray (RAL7035)

Features:









- Heavy duty, 16-gauge steel, 19" table top rack cabinet...
- For ventilated versions link to our [RCHV series](#)...
- Panel rails are infinitely adjustable (front to back), round hole punched for 10-32 clip-nuts to full EIA hole centers (5/8 - 5/8 - 1/2 inch spacing)...
- Includes two pairs of rails (for rear support of heavier equipment), rubber feet, black ABS plastic handles, a starter pack of 10-32 clip nuts & matching **1421ABK** black screws...
- Supplied unassembled (four cabinet pieces & four rails), shipped in a flat pack container for handling ease & protection (see photo below)...
- Simple assembly using one bolt in each corner to lock the sides to the top and bottom (hardware included)...
- Overall width 21"...
- Overall height 2" over panel space...
- Front & back lip is .585" so usable depth is reduced by 1.17"
- Recommended maximum weight (RCHS1902824 tested) - 800 pounds...
- Rugged textured powder paint finish...
- Stocked in Black & Light Gray (RAL7035)...



17.5" Deep models:













Part Number	Color	 Reader File	AutoCAD .dxf File (zipped)	Panel Height		Number of Clip Nuts Included	Wt. lbs.
				Inches	Units		
RCHS1900817BK1 RCHS1900817CG1 RCHS1900817LG1	Black Beige Light Gray	 63K	 59K	8.75	5	8	38
RCHS1901017BK1 RCHS1901017CG1 RCHS1901017LG1	Black Beige Light Gray	 60K	 61K	10.50	6	16	40
RCHS1901417BK1 RCHS1901417CG1 RCHS1901417LG1	Black Beige Light Gray	 64K	 60K	14.00	8	16	44
RCHS1901717BK1 RCHS1901717CG1 RCHS1901717LG1	Black Beige Light Gray	 67K	 63K	17.50	10	16	50
RCHS1902217BK1 RCHS1902217CG1 RCHS1902217LG1	Black Beige Light Gray	 70K	 65K	22.75	13	16	54
RCHS1902817BK1 RCHS1902817CG1 RCHS1902817LG1	Black Beige Light Gray	 72K	 67K	28.00	16	16	60

24.5" Deep models:



Part Number	Color	 Reader File	AutoCAD .dxf File (zipped)	Panel Height		Number of Clip Nuts Included	Wt. lbs.
				Inches	Units		
RCHS1901024BK1 RCHS1901024CG1 RCHS1901024LG1	Black Beige Light Gray	 68K	 60K	10.50	6	16	52
RCHS1901424BK1 RCHS1901424CG1 RCHS1901424LG1	Black Beige Light Gray	 64K	 60K	14.00	8	16	58
RCHS1901724BK1 RCHS1901724CG1 RCHS1901724LG1	Black Beige Light Gray	 64K	 60K	17.50	10	16	62
RCHS1902224BK1 RCHS1902224CG1 RCHS1902224LG1	Black Beige Light Gray	 66K	 60K	22.75	13	16	70

RCHS1902824BK1	Black			28.00	16	16	78
RCHS1902824CG1	Beige						
RCHS1902824LG1	Light Gray	82K	60K				

31.5" Deep models:

Part Number	Color	 Reader File	AutoCAD .dxf File (zipped)	Panel Height		Number of Clip Nuts Included	Wt. lbs.
				Inches	Units		
RCHS1901031BK1 RCHS1901031LG1	Black Light Gray	 62K	 54K	10.50	6	16	64
RCHS1901431BK1 RCHS1901431LG1	Black Light Gray	 63K	 54K	14.00	8	16	68
RCHS1901731BK1 RCHS1901731LG1	Black Light Gray	 63K	 53K	17.50	10	16	74
RCHS1902231BK1 RCHS1902231LG1	Black Light Gray	 65K	 53K	22.75	13	16	86
RCHS1902831BK1 RCHS1902831LG1	Black Light Gray	 66K	 54K	28.00	16	16	94

Feature Views:

<p>Ships Flat For Handling Ease & Protection</p>	<p>Interior View With Infinitely Adjustable Panel Rails</p>
	
<p>Panel Rails (Two Pair Included) With 10-32 Black Clip Nuts & Mounting Hardware</p>	



Accessories:



Casters - Part Number **1425PHD**













- **SOLD IN A SET OF 4**
- Base of cabinet is punched to accept this caster set
- 600# Mfg's specified weight capacity (Set of 4)
- Features ball bearing swivel and hard composition wheels
- Small foot print 2.125" x 15/16" hole mounting pattern
- Wheels are grey & 2" wheel diameter (adds only 2.5" to overall rack height).
- Includes mounting hardware



Doors

- 16-gauge steel construction
- Both front & back of "RCHS" rack cabinets are punched to accept these doors
- Mounts either right or left hand hinge (door & cabinet are symmetrical)
- Includes installed lock and two keys
- Finished in rugged textured powder paint to match RCHS/RCHV enclosures
- Includes mounting hardware

Part Number	Color	 Reader	AutoCAD .dxf File	Use With Cabinet	Wt. lbs.
-------------	-------	---	----------------------	------------------------	-------------

		File	(zipped)	Panel Height	U's
RCHE1908BK1 RCHE1908CG1 RCHE1908LG1	Black Beige Light Gray	 17K	 17K	8" (5 U)	5
RCHE1910BK1 RCHE1910CG1 RCHE1910LG1	Black Beige Light Gray	 18K	 18K	10.5" (6 U)	5
RCHE1914BK1 RCHE1914CG1 RCHE1914LG1	Black Beige Light Gray	 19K	 20K	14" (8 U)	6
RCHE1917BK1 RCHE1917CG1 RCHE1917LG1	Black Beige Light Gray	 21K	 22K	17.5" (10 U)	7
RCHE1922BK1 RCHE1922CG1 RCHE1922LG1	Black Beige Light Gray	 22K	 24K	22.75" (13 U)	9
RCHE1928BK1 RCHE1928CG1 RCHE1928LG1	Black Beige Light Gray	 24K	 27K	28" (16 U)	12



Extra Panel Rails

- RCHS rack cabinets ship with two pair - order below for extra mounting capabilities
- **Sold in pairs**
- Finished in rugged black textured powder paint
- Includes amhal strut mounting hardware (black clip nuts are not included)

Part Number	Use With Cabinet Panel Height
RCHR1908	8" (5 U)
RCHR1910	10.5" (6 U)
RCHR1914	14" (8 U)
RCHR1917	17.5" (10 U)
RCHR1922	22.75" (13 U)



Extra Spring Nuts - Part Number **1421SN**

- 1/4 - 20 Strut nut
- 1/4 - 20 x 1/2 bolt
- Used only in our RCHS & RCHV table top rack cabinets - handy for mounting of other equipment to the horizontal struts
- **Sold in packages of 8 (8 spring nuts and 8 bolts) as shown**



Replacement Rubber Feet - Part Number **1421RC24**

- RCHS rack cabinets ship with four feet included - order these for replacement
- **Sold in package of 20**



PART No. RCHS1902231
 for more information visit
www.hammfg.com
 Data subject to change without notice.
 Isometric drawing not to scale.
 Shipped knockdown for handling ease
 & protection.

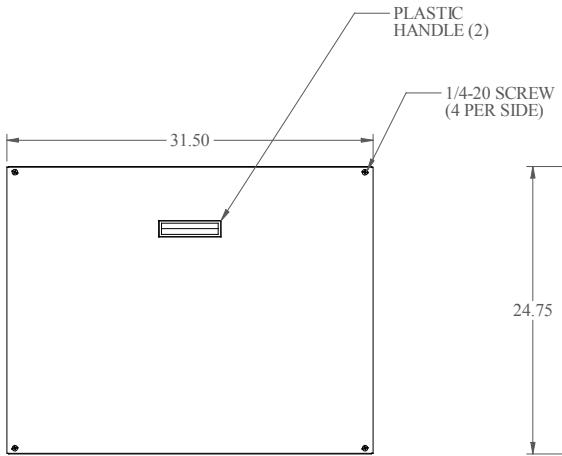

L.S. VIEW

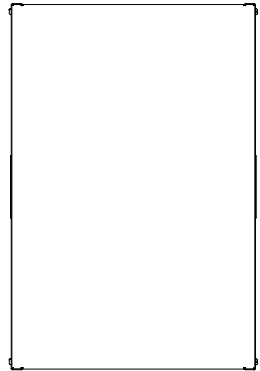

TOP VIEW

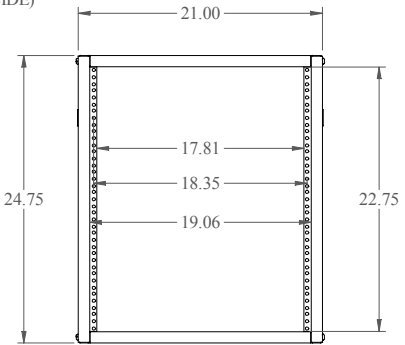

FRONT VIEW

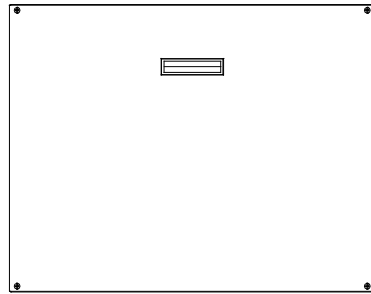
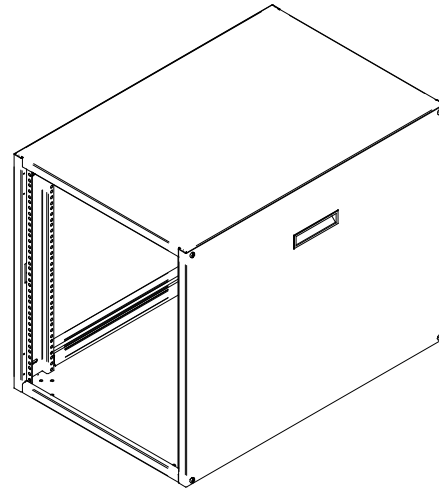

R.S. VIEW

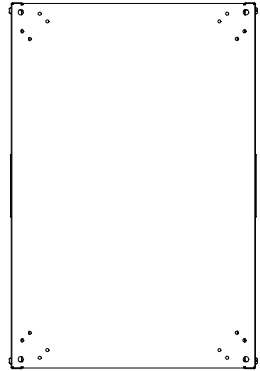

BOTTOM VIEW